

**Mini-PLC STG-570  
Art. No. 0850-0570**

**MANUAL**



**TABLE OF CONTENT**

<b>1</b>	<b>SAFETY INSTRUCTIONS</b> .....	<b>2</b>
<b>2</b>	<b>DESTINATED USE</b> .....	<b>2</b>
<b>3</b>	<b>DISCLAIMER</b> .....	<b>2</b>
<b>4</b>	<b>PRODUCT DESCRIPTION</b> .....	<b>2</b>
<b>4.1</b>	<b>Features</b> .....	<b>2</b>
<b>4.2</b>	<b>Applications</b> .....	<b>2</b>
<b>4.3</b>	<b>General description</b> .....	<b>2</b>
<b>4.4</b>	<b>CAN Programming with miCon-L</b> .....	<b>3</b>
<b>4.5</b>	<b>Delivery content</b> .....	<b>3</b>
<b>5</b>	<b>INSTALLATION</b> .....	<b>3</b>
<b>5.1</b>	<b>Mounting</b> .....	<b>3</b>
<b>5.2</b>	<b>Wiring</b> .....	<b>3</b>
5.2.2	Connecting the power supply .....	4
5.2.3	Connecting the inputs .....	4
5.2.4	Connecting the outputs .....	4
5.2.5	Connecting the CAN interface .....	4
<b>6</b>	<b>OPERATION AND PROGRAMMING</b> .....	<b>5</b>
<b>6.1</b>	<b>Software download</b> .....	<b>5</b>
<b>6.2</b>	<b>Virtual COM port driver installation</b> .....	<b>5</b>
<b>6.3</b>	<b>miCon-L Software Installation</b> .....	<b>5</b>
<b>6.4</b>	<b>Connecting the Mini-PLC</b> .....	<b>5</b>
<b>6.5</b>	<b>First steps in miCon-L</b> .....	<b>5</b>
<b>7</b>	<b>APPENDIX</b> .....	<b>7</b>
<b>7.1</b>	<b>Specifications</b> .....	<b>7</b>
7.1.1	General .....	7
7.1.2	Power supply .....	7
7.1.3	Inputs .....	7
7.1.4	Outputs .....	7
7.1.5	CAN interface .....	7
7.1.6	Security features .....	7
7.1.7	Program and data memory .....	7
7.1.8	Timebase (oscillator) .....	8
7.1.9	Electrical connection .....	8
7.1.10	Electromagnetic compatibility (EMC) .....	8
7.1.11	Environmental conditions .....	8
7.1.12	Weight and dimensions .....	8
7.1.13	Ordering information .....	8
<b>7.2</b>	<b>Documents, videos and software</b> .....	<b>8</b>
<b>7.3</b>	<b>Disposal</b> .....	<b>8</b>
<b>7.4</b>	<b>Conformity declaration</b> .....	<b>8</b>

## 1 SAFETY INSTRUCTIONS

This manual contains notices which you should observe to ensure your own personal safety, as well as to protect the product and the connected equipment. These notices are highlighted in the manual by a warning symbol and are marked as follows according to the level of danger:



**Only qualified personnel should be allowed to install and work on this equipment. Qualified persons are defined as persons who are authorized to commission, to ground and to tag circuits, equipment and systems in accordance with established safety practices and standards.**



**Turn off the power supply before performing any wiring operations! Short circuits can be harmful, critical and can cause explosions and serious burns!**



**Please read this manual carefully and observe all safety instructions!**

## 2 DESTINATED USE

The Mini-PLC is designed for universal measuring, controlling and regulating applications. It must not be used for life critical, medical or fail safe applications.

## 3 DISCLAIMER

BARTH Elektronik GmbH assumes no liability for usage and functionality of the Mini-PLC in case of disregarding this manual. The strict accordance of this manual is important since the installation methods, peripheral connections, usage and maintenance can not be controlled by BARTH Elektronik GmbH. Therefore BARTH Elektronik GmbH assumes no liability for any claim.

## 4 PRODUCT DESCRIPTION

The picture below shows the BARTH® Mini-PLC STG-570 with the connection cable VK-16 (Art. No. 0091-0016). The Mini-PLC is shipped without the USB connection cable VK-16.



### 4.1 Features

- 3 analog Inputs 0 to 30 VDC, 12 bit ADC
- 2 digital Inputs up to 1 kHz
- 4 Power Outputs up to 1.5 A
- 1 Power PWM Output 2 A/1 to 10 kHz
- 1 CAN 2.0A/B Interface
- Reliable Solid-State Outputs
- Fail Safe Oscillator
- Programmable Status LED
- TTL-232/USB Connection to PC
- Intuitive graphical Programming Capability
- Wide Operating Voltage Range 7 to 32 VDC
- Wide Operating Temp. Range -40 to +70°C
- Vibration resistant and rugged Sealing
- Super-flat Housing
- Engineered and manufactured in Germany

### 4.2 Applications

- Industrial Automation
- Building Automation
- Automotive and Maritime Technology
- Environmental Technology
- Light and Show Technology

### 4.3 General description

The tiny STG-570 extends the established BARTH® Mini-PLC series with the smallest model featuring a rugged CAN interface with graphical programming capability.

The Mini-PLC provides outstanding graphical programming at lowest current consumption and the well-known small form factor. The CAN bus allows the user to connect a variety of network components to the Mini-PLC, for example displays, stepper motors or CAN sensors.

The STG-570 does not need any peripheral components to operate. Both inputs and outputs features highly integrated and rugged protection circuits to operate the Mini-PLC in really harsh environment.

These outstanding features open up a variety of application fields in industrial, automotive and 12/24V battery-powered applications.

The STG-570 is also available as customer-tailored OEM version.

#### 4.4 CAN Programming with miCon-L

Without learning a difficult programming language the BARTH® Mini-PLC can be easily programmed using simple and vivid graphical function blocks. This block design meets graphical standards of the latest graphical programming languages.

The miCon-L software suite features (CAN) programming, simulation and test in one unique software design tool. The flexible programming option offers a variety of possibilities in industrial, automotive and maritime applications.

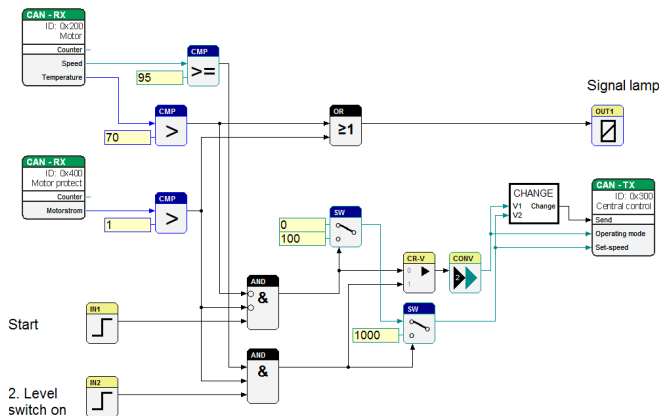

Programming the STG-570 follows using the USB port of your PC with installed miCon-L software suite and the VK-16 USB Connection Cable. The miCon-L Software supports full simulation and visualisation operation modes. miCon-L provides a variety of visualisation blocks and interactive elements to control and debug the Mini-PLC.

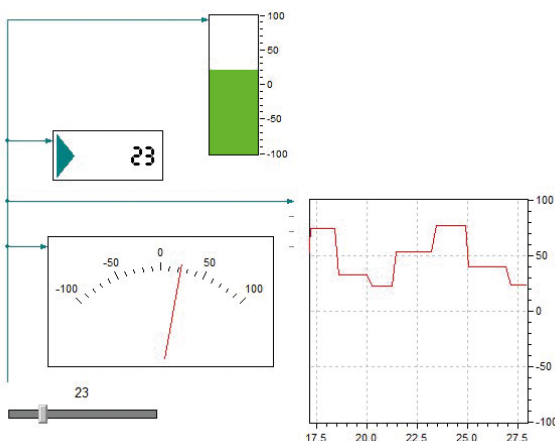

For detailed information please read the BARTH® miCon-L manual and the BARTH® Application Notes on:

[www.micon-l.de](http://www.micon-l.de)  
[www.barth-elektronik.de](http://www.barth-elektronik.de)

#### 4.5 Delivery content

- BARTH® Mini-PLC STG-570 CAN
- Spring terminal connectors (for supply, CAN, I/O)

## 5 INSTALLATION

### 5.1 Mounting



**The Mini-PLC must be installed and wired by a trained technician who knows and complies with both the universally applicable engineering rules and the regulations and standards that apply in specific cases.**

Fastening the STG-570 follows using either the integrated mounting holes for screws or the holes for cable ties. The cable tie installation method is recommended for fastening the STG-570 on wiring harness, tubes or other mechanical parts.

**Take care to meet the environmental conditions of the STG-570.**

### 5.2 Wiring

#### 5.2.1 Overview

The graphic below shows the connection layout of the BARTH® Mini-PLC STG-570.

**X1 connector: supply and CAN pins**

**X2 connector: inputs and outputs**

**X4 connector: TTL-232/USB interface (VK-16)**

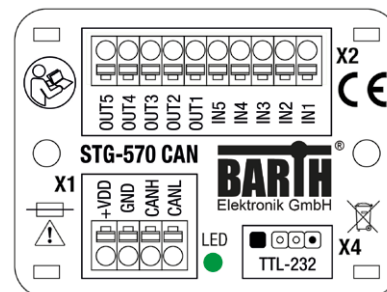

## 5.2.2 Connecting the power supply

The STG-570 features an outstanding wide supply voltage range from 7 to 32 VDC at lowest current consumption. So the Mini-PLC can be integrated within battery supplied 12V or 24V DC systems (cars, trucks, battery powered cars, forklifts and digger, for example).



**Turn off the power supply before performing any wiring operations!**



**False electrical connection, voltage reversal or disregarding the electrical specifications may cause irreversible damage of the Mini-PLC!**

Connect the supply voltage of 7 to 32 VDC to the 4-pole terminal X1 of the STG-570. Wire the positive supply to the ‚+VDD‘ marked connection. The negative (ground) will be wired to the ‚GND‘ connection. All terminals are carried out as plugable spring terminal connectors for a wire gauge of 0.25 to 1.5mm<sup>2</sup>.



**Ensure correct power supply voltage range and polarisation! External fusing of 5A max. is mandatory! Disregarding may cause irreversible damage of the PLC!**

## 5.2.3 Connecting the inputs

You can connect sensors, switches or buttons to the inputs. The sensors may be temperature, flow, pressure, photoelectric sensors or proximity switches, for example. The STG-570 is well suitable for any sensor featuring a voltage output, 0 to 10 VDC, for example.

### Common features of the inputs

- IN1 to IN3 are selectable analog/digital inputs
- IN4 and IN5 are pure digital inputs (up to 1kHz)
- Wide input voltage range 0 to 32VDC
- IN1 to IN3 are 0 to 10 V compatible
- Comprehensive integrated protection circuits
- Outstanding electromagnetic compatibility (EMC)
- Electrostatic discharge protection (ESD)

Due to the pull-down resistors integrated in the STG-570 any switch (NO/NC) can simply be connected between the positive supply (VDD) of the STG-570 and the desired input.



**The voltage at any input must not exceed 32VDC referred to ground (GND). Higher voltages or reverse voltage lower than -32VDC may cause irreversible damage of the Mini-PLC!**

The 10-pole connector named X2 contains the inputs of the Mini-PLC. While IN4 and IN5 are pure digital inputs, IN1 to IN3 provide both digital or analog functionality. The voltage range for all inputs may not exceed 32 VDC. All inputs refer to GND. Please refer to the appendix for detailed electrical specification of the inputs.

## 5.2.4 Connecting the outputs

Depending on load type and current the STG-570 is able to drive electric loads directly without any additional driver or protection circuit. The Mini-PLC provides 4 digital solid-state highside outputs and 1 solid-state lowside switch.

### Common features of outputs OUT1 to OUT4

- Rugged solid-state highside switch up to 1.5A
- Paralleling permissible up to 4A
- Short circuit protection and current limitation
- Fast demagnetization of inductive loads
- Stable behaviour at undervoltage
- Comprehensive integrated protection circuits
- Outstanding electromagnetic compatibility (EMC)
- Electrostatic discharge protection (ESD)

### Features of output OUT5

- Solid state lowside switch with PWM capability
- Sinks up to 2A
- Rugged solid-state design
- Fast demagnetization of inductive loads
- Outstanding electromagnetic compatibility (EMC)
- Electrostatic discharge protection (ESD)

The 10-pole connector X2 contains the digital outputs of the Mini-PLC. While OUT1 to OUT4 are overload-protected highside switches, OUT5 is carried out as lowside switch with PWM capability without short circuit protection. A logical HIGH within miCon-L will switch the Mini-PLC's supply voltage at OUT1 to OUT4, while OUT5 switches lowside (GND). Avoid a sink current exceeding 2A at OUT5 because this outputs is not protected against short-circuiting or overload current !



**The total current sourced by OUT1 to OUT4 must not exceed 4A! Avoid reverse voltage at any output higher than the Mini-PLC's supply voltage! OUT5 provides NO short circuit protection. Take care the sink current not exceeds 2A! Negligence may cause irreversible damage of the Mini-PLC!**

Please refer to the appendix for detailed electrical specification of the outputs.

## 5.2.5 Connecting the CAN interface

The X1 connector of the STG-570 contains the CAN specific ‚CANH‘ and ‚CANL‘ pins.



**The voltage at CANH or CANL must not exceed -27 or +40 VDC referred to ground (GND). Higher voltages may cause irreversible damage of the Mini-PLC!**

There is no termination resistor integrated in the STG-570. Please refer to the appendix for detailed electrical specification of the CAN interface.

## 6 OPERATION AND PROGRAMMING

### 6.1 Software download

BARTH® supplies a free software license download package for Microsoft® WINDOWS® which includes:

- Virtual COM port driver for USB connection
- miCon-L Software Suite
- Sample Programs for BARTH® Mini-PLC

Please download this package from:  
[www.micon-l.de](http://www.micon-l.de)

### 6.2 Virtual COM port driver installation

Before you connect the Mini-PLC to the PC you have to install the USB-/COM-port driver (folder ,USBdriver“) from the software download package. Please follow the instructions of the SETUP routine.

### 6.3 miCon-L Software Installation

Now install the miConL software suite from the ,miCon-L“ folder. Select your language file and follow the setup instructions of miConL.

### 6.4 Connecting the Mini-PLC

To operate the STG-570, first establish proper power supply connection to the X1 connector.

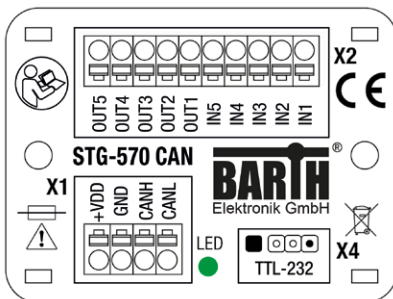

For programming and PC connection the USB connection cable VK-16 (Art. No. 0091-0010) and a PC with installed Windows operating system are mandatory. For Mini-PLC connection please use the 3-way X4 terminal.

### 6.5 First steps in miCon-L

Establish the PC connection using the VK-16 connection cable and run miConL. For choosing the correct virtual COM-Port please click the right button (configure serial interface) located on the main menu page and confirm the added virtual COM-Port used by the STG-570.

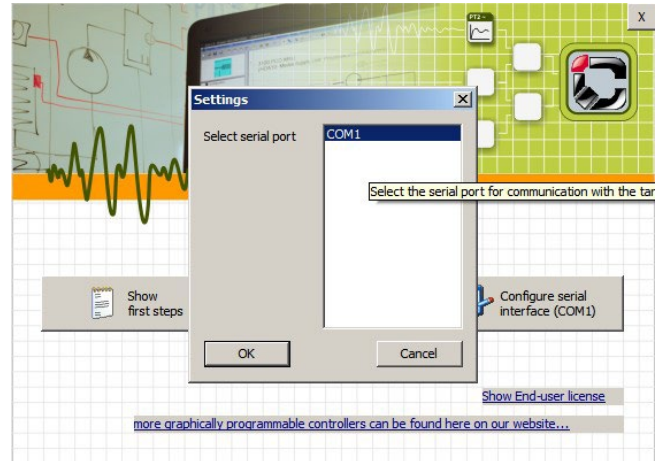

Now start miConL with creating a new project (Project->New) or open a miCon-L sample application (Project->Open).

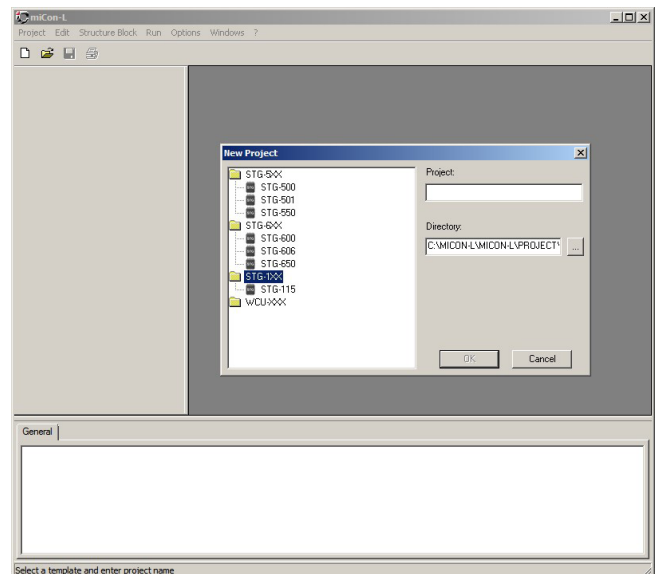

Creating a new project the desired Mini-PLC model and the project name have to be defined. After opening or creating a project the workspace of miConL with it's libraries (right) is shown.

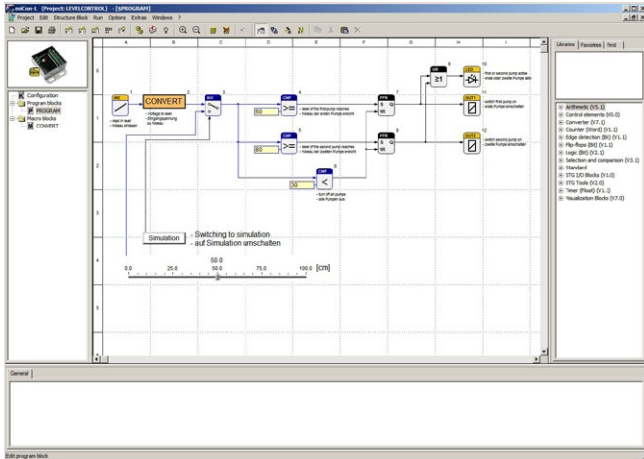

Additional help and a detailed user manual is provided within the miCon-L help and the miConL context menu (right mouse button).

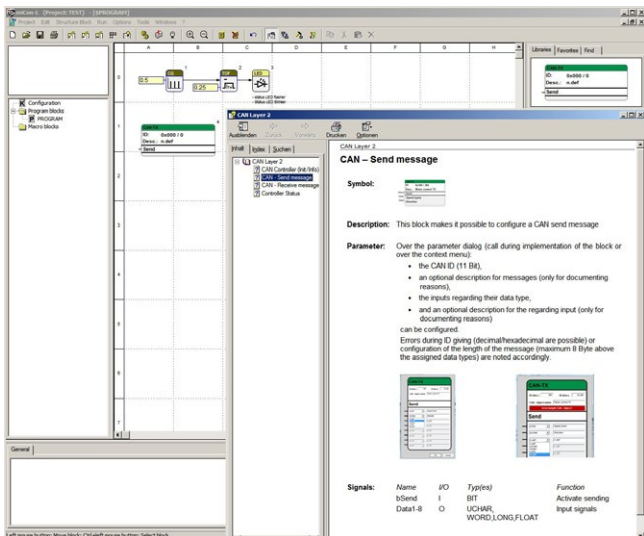

You can find sample programs in the ‚SAMPLE\_PROGS‘ folder which is part of the miCon-L download package.

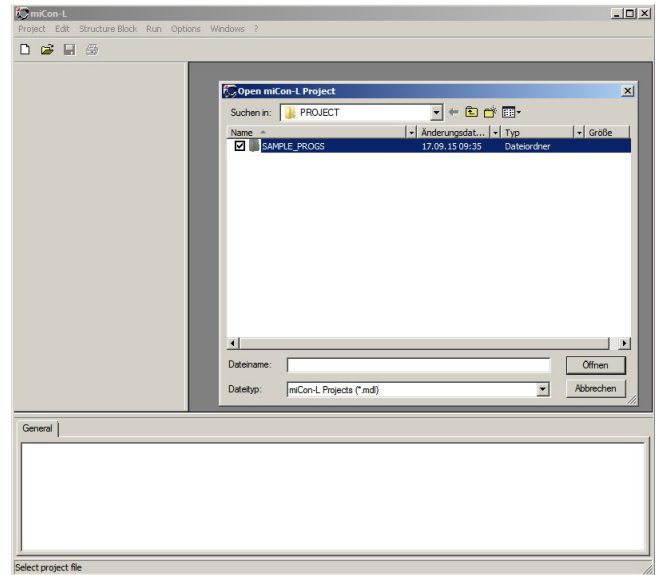

For detailed information and help please have a closer look at the documents related to the miCon-L Software Suite:

<http://www.micon-l.de>

## 7 APPENDIX

### 7.1 Specifications

#### 7.1.1 General

<b>Hardware design</b>	BARTH <sup>®</sup> Mini-PLC fully enclosed in proprietary PU resin, tiny and rugged housing with plugable spring terminal connectors, ultra-lightweight
<b>Programming</b>	miCon-L Software, graphical (function block style), simulation, (CAN) programming and visualisation, free license
<b>Interfaces</b>	TTL-232 (5V TTL level)  USB (VK-16 required) reserved for miCon-L software communication  CAN2.0A/B

#### 7.1.2 Power supply

<b>Operating voltage</b>	7 to 32 VDC
<b>Current consumption</b>	nominal 15 mA at 32 VDC (depending on configuration)
<b>Fusing</b>	5 A max. (external) mandatory for voltage reversal protection
<b>Voltage reversal protection</b>	yes (combined with external fuse)
<b>ESD/TVS protection</b>	yes
<b>Heat dissipation air (at full load)</b>	normally < 2 W

#### 7.1.3 Inputs

<b>Number digital</b>	2+3
<b>Number analog</b>	3
<b>Digital input IN4 - IN5</b>	$U_{IN} = 0..30$ VDC $R_{IN} > 30$ kOhm $U_{LOW} \leq 2$ VDC $U_{HIGH} > 4$ VDC $f_{IN} \leq 1$ kHz $t_{IN} \geq 1$ ms
<b>Analog input IN1 - IN3</b>	$U_{IN} = 0..30$ VDC $R_{IN} > 11$ kOhm $f_{IN} \leq 100$ Hz $t_{IN} \geq 10$ ms
<b>Accuracy ADC IN3 - IN5</b>	$\pm 1\%$ (<0.25 VDC)
<b>ADC resolution (internal)</b>	12 Bit
<b>Potential isolation</b>	no (common GND)
<b>ESD/TVS protection</b>	yes
<b>Permissible cable length (per input)</b>	normally 40 m

#### 7.1.4 Outputs

<b>Number digital</b>	4+1
<b>Number PWM</b>	1
<b>Output OUT1 - OUT4</b>	Output type: solid state (highside)  $I_{OUT} \leq 1.5$ A (resistive load) @ $f_{OUT} = 0$ to 100 Hz $U_{OUT} \geq U_{IN} - 0,45$ V  $I_{TOT} \leq 4$ A (paralleling permissible)  Maximal allowable load inductance for a single switch off (one output): $V_{DD} = 12$ VDC, $I_L = 1.5$ A, $Z_L \leq 70$ mH $V_{DD} = 12$ VDC, $I_L = 1$ A, $Z_L \leq 200$ mH  On-state resistance $V_{DD}$ to OUT: $R_{ON} \leq 180$ mOhm  Turn-on time: $t_{ON} \leq 250$ $\mu$ s Turn-off time: $t_{OFF} \leq 270$ $\mu$ s
<b>PWM output OUT5</b>	Output type: solid state (lowside)  $I_{OUT} \leq 2$ A (resistive load) @ $f_{OUT} = 1$ kHz to 10 kHz $I_{OUT} \leq 1$ A (resistive load)
<b>Potential isolation</b>	no

#### 7.1.5 CAN interface

<b>CAN</b>	CAN 2.0A: 11 bit ID, base frame format  CAN 2.0B: 29 bit ID, extended frame format  Baud rate: 100, 125, 250, 500 kbit  Meets or exceeds the requirements of applications ISO 11898-2, loss of ground protection from -27 V to 40 V, thermal shutdown protection
------------	---

#### 7.1.6 Security features

<b>Security Features</b>	Watchdog (WD) Fail safe oscillator 16 MHz (FSO) Brown out detection (BOD) Power up timer (PUT)
--------------------------	---

#### 7.1.7 Program and data memory

<b>Flash program memory</b>	64 k cell endurance: 10.000 min characteristic retention: 40 yrs
<b>EEPROM data memory</b>	1024 byte byte endurance 100.000 min. characteristic retention: 40 yrs

### 7.1.8 Timebase (oscillator)

<b>Primary Oscillator</b>	Crystal quartz MEMS unit (precise „micro-electro-mechanical system“)
<b>Nominal Frequency</b>	16.000 MHz
<b>Frequency tolerance</b>	$\pm 50 \times 10^{-6}$
<b>Frequency aging</b>	$\pm 5 \times 10^{-6}$ / year max.
<b>Second Fail Safe Oscillator</b>	16 MHz

### 7.1.9 Electrical connection

<b>Electrical Connection</b>	plugable spring terminal connectors 0.25 to 1.5 mm <sup>2</sup>  Manufacturer: Phoenix Contact Series: COMBICON Type: FMC1,5/x-ST-3,5
------------------------------	---

### 7.1.10 Electromagnetic compatibility (EMC)

<b>Electrostatic discharge (ESD) on IN1 to IN5</b>	20 kV air discharge 30 kV contact discharge (IEC/EN 61 000-4-2, level 3)
<b>Electrostatic discharge (ESD) on OUT1 to OUT5</b>	8 kV (human body model) (MIL-STD883D)
<b>Electrostatic discharge (ESD) on CAN pins</b>	ESD Protection up to $\pm 12$ kV (Human-Body Model)
<b>Electromagnetic fields</b>	Field strength 10 V/m (IEC/EN 61000-4-3)

### 7.1.11 Environmental conditions

<b>Operation temperature</b>	-40..+60 °C (IEC 60068-2-1/2)
<b>Storage temperature</b>	-40..+70 °C (IEC 60068-2-1/2)
<b>Relative humidity</b>	5 to 95% non-condensing (IEC 60068-2-30)
<b>Air pressure (in operation)</b>	500 to 1500 hPa
<b>Shock resistance</b>	min. 100 m/s <sup>2</sup> (IEC 60068-2-27)
<b>Vibration resistance</b>	min. 50 m/s <sup>2</sup> @ 10..150 Hz (IEC 60068-2-6)
<b>Degree of protection</b>	IP 20, limited by connectors (EN 50178, IEC 60529)
<b>Drop</b>	Drop height: 500mm (IEC 60068-2-31)
<b>Free fall (packaged)</b>	1500 mm (IEC 60068-2-32)

### 7.1.12 Weight and dimensions

<b>Weight</b>	50 g (without connectors)
<b>Dimensions</b>	60 x 45 x 11 mm (LxWxH)
<b>Mounting</b>	via two M4 screws or 3.6mm cable ties

### 7.1.13 Ordering information

<b>Ordering information Mini-PLC</b>	Mini-PLC STG-570 Art. No. 0850-0570 GTIN 4251329400163
<b>Ordering information accessory</b>	USB connection cable VK-16 Art. No. 0091-0016 GTIN 4251329400187

## 7.2 Documents, videos and software

Detailed information, additional documents, application notes and videos relating to this product are downloadable from [www.barth-elektronik.de](http://www.barth-elektronik.de) and [www.micon-l.de](http://www.micon-l.de)

## 7.3 Disposal



**If you wish to finally dispose of the product, ask your local recycling centre or dealer for details about how to do this in accordance with the applicable disposal regulations.**

## 7.4 Conformity declaration

For the following designated product it is hereby confirmed, that the construction in that technical design brought by us in traffic corresponds to the standards specified below. In the event of any alternation which has not been approved by us being made to any device as designated below, this statement shall thereby be made invalid.

<b>Description</b>	Mini-PLC
<b>Type</b>	STG-570
<b>Art. No.</b>	0850-0570
<b>Directive 2004/108/EG relating to electromagnetic compatibility (EMC)</b>	Applied norms: 2004/108/EG 2004/108/EC 2014/30/EU
	
<b>RoHS Directive 2011/65EU</b>	We hereby declare that our product is compliant to the RoHS Directive on restriction of the use of certain hazardous substances in electrical and electronic appliances.

BARTH<sup>®</sup> Elektronik GmbH

Lengerich, 03.08.2016

*D. Barth*

Dipl.-Ing. (FH) D. Barth  
Managing Director